

	[kg]	Art.-Nr.
<b>Kletterkonsole MF240</b> Climbing bracket MF240	172,1	580650000
bestehend aus:		
(A) <b>Horizontalprofil MF mit Geländer</b> Länge: 251 cm Höhe: 155 cm	88,5	581618000
(B) <b>Vertikalprofil MF80</b> Höhe: 213 cm	44,0	580652000
(C) <b>Druckstrebe MF lang</b> verzinkt Länge: 252,9 cm	24,7	580653000
(D) <b>Druckstrebe MF kurz</b> verzinkt	16,3	580654000

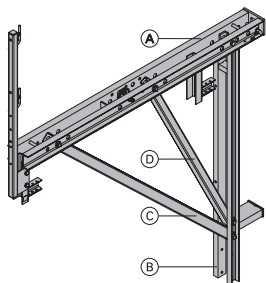

<b>Fahreinheit MF</b> Travelling unit MF	135,6	580655000
bestehend aus:		
(A) <b>Fahrwerk MF</b> verzinkt Länge: 128 cm Höhe: 22 cm	32,3	580656000
(B) <b>Einrichtungsspindel MF 3,00m</b> Länge: 166-229 cm	23,0	580657000
(C) <b>Fahrriegel MF 3,00m</b> verzinkt	76,8	580658000

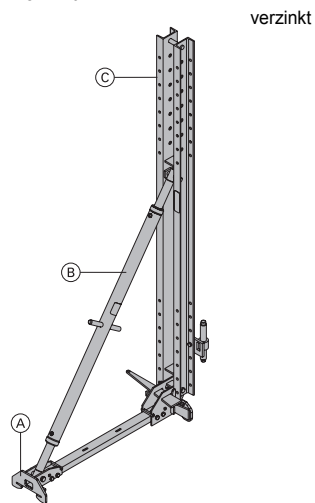

<b>Einrichtungsspindel MF 4,50m</b> Plumbing spindle MF 4.50m	46,0	580664000
verzinkt Länge: 262 - 345 cm		

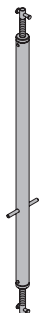

	[kg]	Art.-Nr.
<b>Fahrriegel MF 4,50m</b> Vertical waling MF 4.50m	123,8	580663000
verzinkt		



<b>Fahrriegelverlängerung MF</b> Vertical waling extension MF	41,5	580659000
verzinkt Höhe: 144 cm		









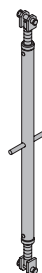

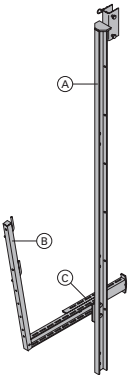
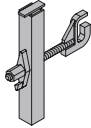

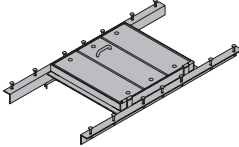

<b>Vertikalprofil MF160</b> Vertical profile MF160	90,5	580660000
verzinkt Höhe: 208 cm		

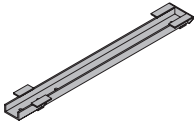
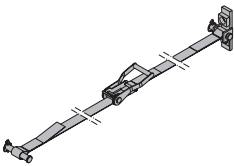
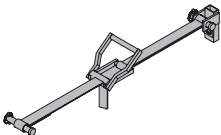

<b>Druckspindel MF240</b> Pressure spindle MF240	26,0	580680000
verzinkt Höhe: 166 - 226 cm		

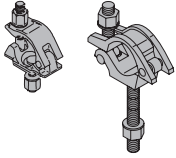

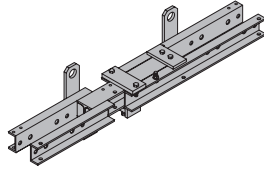
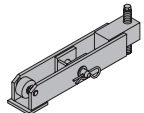
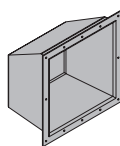
	[kg]	Art.-Nr.		[kg]	Art.-Nr.
<b>Hängebühne MF75 5,00m</b> Suspended platform MF75 5.00m bestehend aus:	<b>69,8</b>	<b>580667000</b>		<b>2,5</b>	<b>580526000</b>
(A) <b>Hängeprofil MF</b> Höhe: 368 cm	<b>43,0</b>	<b>580668000</b>			
(B) <b>Anschraubbühne MF75</b> verzinkt Länge: 113 cm Höhe: 152 cm	<b>19,0</b>	<b>580669000</b>			
(C) <b>Distanzprofil MF</b> Länge: 71 cm	<b>7,8</b>	<b>580670000</b>			
 verzinkt			<b>Keilriegelhalter</b> Waling-to-bracket holder		
			 verzinkt Länge: 26 cm Höhe: 31 cm		
			<b>Schutzgeländerzwinde S</b> Handrail clamp S	<b>11,5</b>	<b>580470000</b>
			 verzinkt Höhe: 123 - 171 cm		
			<b>Universal-Geländerbügel</b> Universal railing shackle	<b>3,0</b>	<b>580478000</b>
			 verzinkt Höhe: 20 cm		
<b>Anschraubbühne MF75</b> Screw-on access bracket MF75	<b>19,0</b>	<b>580669000</b>			
 verzinkt Länge: 113 cm Höhe: 152 cm			<b>Durchstieg</b> Passage	<b>37,0</b>	<b>580832000</b>
			 verzinkt Länge: 134 cm Breite: 72 cm		
<b>Schwenkplatte MF</b> Swivel plate MF	<b>4,5</b>	<b>580672000</b>			
 verzinkt Länge: 29 cm Höhe: 20 cm			<b>Kranseilschleife 3,50m</b> Crane sling 3.50m	<b>8,8</b>	<b>580461000</b>
			 Durchmesser: 16 cm Max. Tragfähigkeit: 1950 kg Betriebsanleitung beachten!		<b>CE</b>
<b>Grundblockriegel MF</b> Starter block unit MF	<b>23,2</b>	<b>580678000</b>			
 verzinkt Länge: 143 cm Breite: 19 cm			<b>Gerüstrohr 48,3mm 1,00m</b>	<b>4,0</b>	<b>682014000</b>
			<b>Gerüstrohr 48,3mm 1,50m</b>	<b>6,0</b>	<b>682015000</b>
			<b>Gerüstrohr 48,3mm 2,00m</b>	<b>8,0</b>	<b>682016000</b>
			<b>Gerüstrohr 48,3mm 2,50m</b>	<b>10,0</b>	<b>682017000</b>
			<b>Gerüstrohr 48,3mm 3,00m</b>	<b>12,0</b>	<b>682018000</b>
			<b>Gerüstrohr 48,3mm 3,50m</b>	<b>14,0</b>	<b>682019000</b>
			<b>Gerüstrohr 48,3mm 4,00m</b>	<b>16,0</b>	<b>682021000</b>
			<b>Gerüstrohr 48,3mm 4,50m</b>	<b>18,0</b>	<b>682022000</b>
			<b>Gerüstrohr 48,3mm 5,00m</b>	<b>20,0</b>	<b>682023000</b>
			<b>Gerüstrohr 48,3mm 5,50m</b>	<b>22,0</b>	<b>682024000</b>
			<b>Gerüstrohr 48,3mm 6,00m</b>	<b>24,0</b>	<b>682025000</b>
			<b>Gerüstrohr 48,3mm .....m</b>	<b>4,0</b>	<b>682001000</b>
			Scaffold tube 48.3mm		
<b>Windabspannung MF/150F/K 6,00m</b> Wind bracing MF/150F/K 6.00m	<b>4,7</b>	<b>580665000</b>	 verzinkt		
			 verzinkt		
<b>Windabspannung MF 6,00m</b> Wind bracing MF 6.00m	<b>4,3</b>	<b>580677000</b>			
			<b>Gerüstrohranschluss</b> Scaffold tube connection	<b>0,27</b>	<b>584375000</b>
			 verzinkt Höhe: 7 cm		

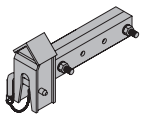
	[kg]	Art.-Nr.
<b>Anschraubkupplung 48mm 50</b> Anschraubkupplung 48mm 95 Screw-on coupler	0,84 0,71	682002000 586013000
 verzinkt Schlüsselweite: 22 mm		
<b>Drehkupplung 48mm</b> Swivel coupler 48mm	1,5	582560000
 verzinkt Schlüsselweite: 22 mm		
<b>Teleskop-Schachträger 1,45-1,65m</b> Teleskop-Schachträger 1,65-2,00m Teleskop-Schachträger 2,00-2,70m Teleskop-Schachträger 2,70-3,80m Teleskop-Schachträger 3,80-5,90m Telescopic shaft beam	56,0 65,0 107,5 156,5 261,0	580686000 580687000 580688000 580689000 580690000
 verzinkt		
<b>Klinke für Schachtbühne</b> Pawl for shaft platform	18,0	580466000
 verzinkt Länge: 55 cm Schlüsselweite: 19 mm		
<b>Aussparungskasten 20x20x15cm</b> Box for latch 20x20x15cm	2,6	580608000
 blau pulverbeschichtet		
<b>Verschlussstopfen 15,0</b> Plug 15.0	0,006	580609000
 farblos Durchmesser: 1,9 cm		
<b>Bühnenkopf</b> Main beam head	14,9	580464000
 blau lackiert Länge: 49 cm		

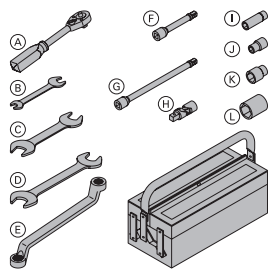
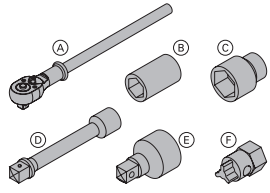
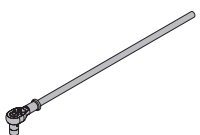
	[kg]	Art.-Nr.
<b>GF-Werkzeugbox</b> Tool box GF	6,5	580390000
Im Lieferumfang enthalten:		
(A) <b>Umschaltknarre 1/2"</b> verzinkt Länge: 30 cm	0,73	580580000
(B) <b>Gabelschlüssel 13/17</b>	0,08	580577000
(C) <b>Gabelschlüssel 22/24</b>	0,22	580587000
(D) <b>Gabelschlüssel 30/32</b>	0,80	580897000
(E) <b>Ringschlüssel 17/19</b>	0,27	580590000
(F) <b>Verlängerung 11cm</b>	0,20	580581000
(G) <b>Verlängerung 22cm</b>	0,31	580582000
(H) <b>Kardangelenk</b>	0,16	580583000
(I) <b>Hülse nuss 19</b>	0,16	580598000
(J) <b>Stecknuss 13</b>	0,06	580576000
(K) <b>Stecknuss 24</b>	0,12	580584000
(L) <b>Stecknuss 30 1/2"</b>	0,20	580575000
		
<b>Zusatzwerkzeuge MF</b> Additional tools MF	4,1	580682000
bestehend aus:		
(A) <b>Umschaltknarre 3/4"</b> verzinkt Länge: 50 cm	1,5	580894000
(B) <b>Stecknuss 17 1/2"</b>	0,07	580685000
(C) <b>Stecknuss 50</b>	0,81	581449000
(D) <b>Verlängerung 20cm 3/4"</b>	0,68	580683000
(E) <b>Übergangsteil A 1/2"x3/4"</b>	0,18	580684000
(F) <b>Universal-Konusschlüssel 15,0/20,0</b> verzinkt Länge: 9 cm Schlüsselweite: 50 mm	0,90	581448000
		
<b>Antriebsknarre MF 3/4"</b> Ratchet MF 3/4"	3,9	580679000
 verzinkt Länge: 108 cm		