

	[kg]	Č. výrobku
Frami-rámový panel 0,90x2,70m	75,0	588481000
Frami-rámový panel 0,75x2,70m	66,4	588449000
Frami-rámový panel 0,60x2,70m	57,8	588465000
Frami-rámový panel 0,45x2,70m	48,0	588482000
Frami-rámový panel 0,30x2,70m	39,0	588483000
Frami-rámový panel 0,90x1,50m	43,3	588406000
Frami-rámový panel 0,75x1,50m	39,7	588448000
Frami-rámový panel 0,60x1,50m	35,0	588464000
Frami-rámový panel 0,45x1,50m	28,2	588409000
Frami-rámový panel 0,30x1,50m	23,0	588410000
Frami-rámový panel 0,90x1,20m	37,0	588401000
Frami-rámový panel 0,75x1,20m	31,9	588447000
Frami-rámový panel 0,60x1,20m	28,4	588463000
Frami-rámový panel 0,45x1,20m	22,8	588404000
Frami-rámový panel 0,30x1,20m	18,8	588405000

Frami-Rahmenelement

pozink.
konštrukčná výška: 9 cm

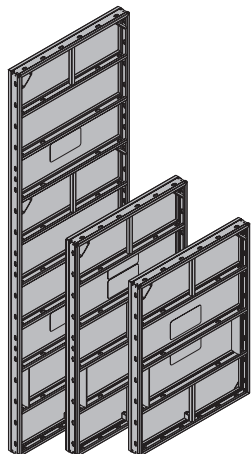

Frami-univerzálny panel 0,75x2,70m	80,8	588484000
Frami-univerzálny panel 0,75x1,50m	46,6	588407000
Frami-univerzálny panel 0,75x1,20m	36,8	588402000

Frami-Universalelement

pozink.
rohy označené modrou farbou
konštrukčná výška: 9 cm

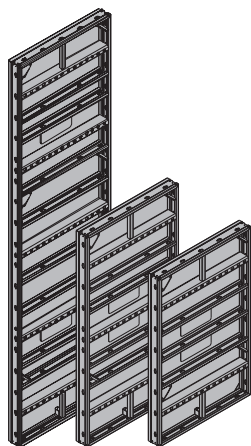

	[kg]	Č. výrobku
Frami-vnútrotný roh 2,70m 20cm	51,6	588485000
Frami-vnútrotný roh 1,50m 20cm	30,7	588472000
Frami-vnútrotný roh 1,20m 20cm	25,3	588471000

Frami-Innenecke

pozink.

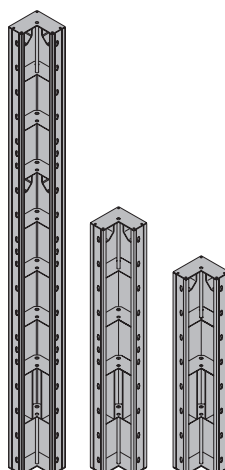

Frami-vonkajší roh 2,70m	23,8	588461000
Frami-vonkajší roh 1,50m	12,9	588460000
Frami-vonkajší roh 1,20m	11,0	588459000

Frami-Außenecke

pozink.

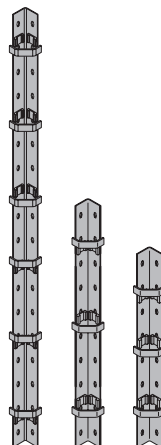

Frami-kíbový roh vnútrotný I 1,20m	33,5	588425000
Frami-kíbový roh vnútrotný I 1,50m	40,0	588426000

Frami-Scharnierecke I

povrstv. práškom modrej farby

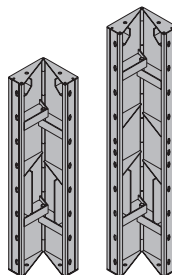







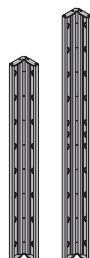

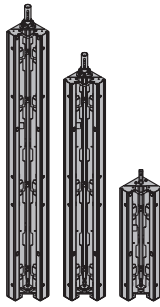
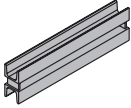

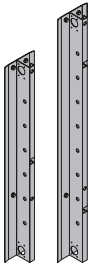
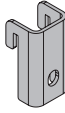
Frami-kíbový roh vonkajší A 1,20m	12,8	588429000
Frami-kíbový roh vonkajší A 1,50m	15,9	588430000

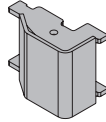
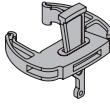
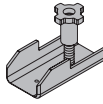

Frami-Scharnierecke A



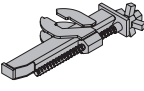
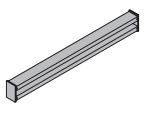
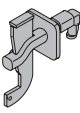
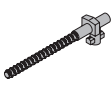
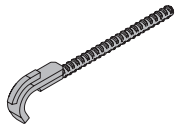
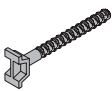
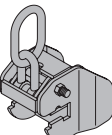



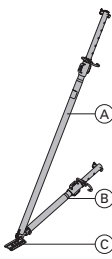
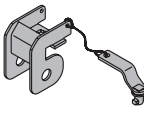
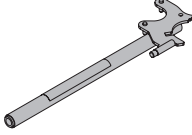

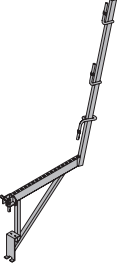

povrstv. práškom modrej farby

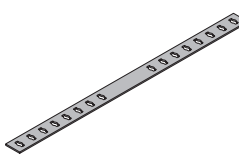

	[kg]	Č. výrobku		[kg]	Č. výrobku	
Frami-oblúčkový plech 0,20x1,50m	21,5	588486000	 <p>povrstv. práškom modrej farby</p>	Framax-oddebňovací roh I 2,70m	171,5	588634000
Frami-oblúčkový plech 0,25x1,50m	22,5	588487000		Framax-oddebňovací roh I 1,35m	90,0	588614000
Frami-oblúčkový plech 0,30x1,50m	23,5	588488000		Framax-oddebňovací roh I 3,30m	211,8	588612000
Frami-Bogenblech				Framax-Ausschalecke I		
						pozinkovaný, povrstv. práškom
						
Frami-kotevný pažďík 0,40m	4,4	588489000	 <p>lakované namodro</p>	Framax-oddebňovacie vreteno I	3,2	588618000
Frami-Ankerriegel 0,40m				Framax-Ausschalspindel I		
				 <p>pozink. výška: 25 cm</p>		
Frami-vyrovnávací plech 15 1,20m	9,7	588467000	 <p>povrstv. práškom modrej farby šírka: 21 cm</p>	Frami-adaptér kotvy pre oddebňov. roh I	0,47	588492000
Frami-vyrovnávací plech 15 1,50m	12,1	588468000		Frami-Ankeradapter für Ausschalecke I		
Frami-Ausgleichsblech				 <p>pozink. výška: 11 cm</p>		
Frami-vyrovnávací hranol 10x9cm 2,70m	12,3	176083000	 <p>lazúrované nažito</p>	Frami-adaptér profilu pre oddebňov. roh I	0,60	588491000
Frami-vyrovnávací hranol 5x9cm 2,70m	6,1	176082000		Frami-Profiladapter für Ausschalecke I		
Frami-vyrovnávací hranol 3x9cm 2,70m	3,7	176081000		 <p>pozink. výška: 8 cm</p>		
Frami-vyrovnávací hranol 2x9cm 2,70m	2,5	176080000				
Frami-vyrovnávací hranol 10x9cm 1,50m	6,0	176035000		Framax-rychloupínač RU	3,3	588153400
Frami-vyrovnávací hranol 5x9cm 1,50m	3,0	176034000		Framax-Schnellspanner RU		
Frami-vyrovnávací hranol 3x9cm 1,50m	1,9	176033000		 <p>pozink. dĺžka: 20 cm</p>		
Frami-vyrovnávací hranol 2x9cm 1,50m	1,2	176032000				
Frami-Passholz						
				Frami-botka panelu	1,3	588490000
				Frami-Elementschuh		
				 <p>pozink. dĺžka: 16 cm</p>		
Frami-uholník k debniacej škrupine 21mm	2,1	588474000	 <p>pozink. výška: 56 cm</p>	Frami-upínač	1,2	588433000
Frami-uholník k debniacej škrupine 27mm	2,0	588473000		Frami-Spanner		
Frami-Schalhautwinkel				 <p>pozink. dĺžka: 11 cm</p>		
				Frami-smerový upínač	3,2	588435000
				Frami-Richtspanner		
				 <p>pozink. dĺžka: 62 cm</p>		

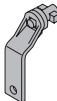
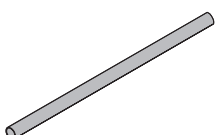
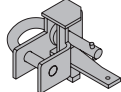
	[kg]	Č. výrobku
Frami-vyrovňovací upínač Frami-Ausgleichsspanner  pozink. dĺžka: 40 cm Kotevné tyče nezvárajte a nezohrievajte – hrozí nebezpečenstvo zlomenia!	3,6	588436000
Frami-upínacia koľajnica 0,70m Frami-upínacia koľajnica 1,25m Frami-Klemmschiene  lakované namodro	3,7 6,4	588439000 588440000
Frami-zvierka Frami-Klemme  pozink. dĺžka: 16 cm	1,1	588441000
Frami-univerzálna spojka 5-12cm Frami-Universalverbinder 5-12cm  pozink. dĺžka: 23 cm jednotka balenia: 60 ks	0,43	588479000
Frami-spojka profilu 5-18cm Frami-Profilverbinder 5-18cm  pozink. dĺžka: 33 cm	0,80	588493000
Frami-rohová spojka Frami-Eckverbinder  pozink. dĺžka: 19 cm jednotka balenia: 60 ks	0,40	588446000
Frami-žeriavové oko Frami-Umsetzbügel  pozink. šírka: 15 cm výška: 21 cm max.nosnosť: 500 kg Dodržujte návod na použitie!	7,5	588438000
Frami-nastavovacia vzpera 260 Frami-Justierstütze 260  pozink. dĺžka: 145 - 258 cm Dodržujte platné bezpečnostno-technické predpisy!	13,9	588437000

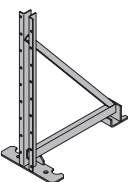
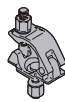
	[kg]	Č. výrobku
Panelová vzpera 340 bez opornej hlavy Elementstütze 340 ohne Stützenkopf skladá sa z: (A) Nastavovacia opora 340 pozink. dĺžka: 190 - 341 cm (B) Nastavovacia opora 120 dĺžka: 80 - 130 cm (C) Pätka vzpery pozink. dĺžka: 20 cm šírka: 11 cm výška: 10 cm	24,0	580365000
 pozink. stav dodávky: zložená Dodržujte platné bezpečnostno-technické predpisy!	14,2	588247000
Hlavica pre Frami-nastavovaciu vzperu 260 Strebenkopf f. Frami-Justierstütze 260  pozink. šírka: 9 cm výška: 14 cm	1,4	508437002
Univerzálny uvoľňovací kľúč Universal-Lösewerkzeug  pozink. dĺžka: 75,5 cm	3,7	582768000
Doka-express-kotva 16x125mm Doka-Expressanker 16x125mm  pozink. dĺžka: 18 cm jednotka balenia: 10 ks Dodržujte montážny návod!	0,31	588631000
Doka-pružinová hmoždinka 16mm Doka-Coil 16mm  pozink. priemer: 1,6 cm jednotka balenia: 100 ks Dodržujte montážny návod!	0,009	588633000
Frami-konzola 60 Frami-Konsole 60  pozink. dĺžka: 98 cm výška: 157 cm Dodržujte platné bezpečnostno-technické predpisy!	7,7	588442000

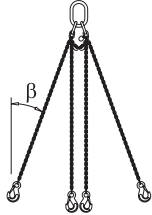
	[kg]	Č. výrobku		[kg]	Č. výrobku
Zverákový stúpič ochranného zábradlia S Schutzgeländerzwinge S  pozink. výška: 123 - 171 cm 	11,5	580470000			
Frami-uzatváracia zátka Frami-Abdeckstopfen  hnedá priemer: 2 cm	0,003	588445000			
Framax-trojhranná lišta 2,70m Framax-Dreikanteleiste 2,70m  jednotka balenia: 50 ks	0,38	588170000			
Frami-držiak kotevnej tyče Frami-Ankerhaltewinkel  pozink. jednotka balenia: 20 ks	0,58	588453000			
Frami-plochá kotva 10-80cm Frami-Flachanker 10-80cm  pozink. dĺžka: 97 cm dovolená nosnosť: 5 kN	2,1	588475000			
Zábradlie 1,00m Geländer 1,00m  pozink. dĺžka: 124 cm	3,8	584335000			
Frami-zástrčný čap Frami-Stecker  pozink. šírka: 3 cm výška: 12 cm jednotka balenia: 70 ks	0,26	588434000			
Lešenárska trubka 48,3mm 1,00m Lešenárska trubka 48,3mm 1,50m Lešenárska trubka 48,3mm 2,00m Lešenárska trubka 48,3mm 2,50m Lešenárska trubka 48,3mm 3,00m Lešenárska trubka 48,3mm 3,50m Lešenárska trubka 48,3mm 4,00m Lešenárska trubka 48,3mm 4,50m Lešenárska trubka 48,3mm 5,00m Lešenárska trubka 48,3mm 5,50m Lešenárska trubka 48,3mm 6,00m Lešenárska trubka 48,3mmm Gerüstrohr 48,3mm  pozink.	4,0 6,0 8,0 10,0 12,0 14,0 16,0 18,0 20,0 22,0 24,0 4,0	682014000 682015000 682016000 682017000 682018000 682019000 682021000 682022000 682023000 682024000 682025000 682001000			
Frami-fundamentový upínač Frami-Fundamentspanner  pozink. výška: 9 cm dovolená nosnosť: 8 kN	1,6	588452000			
Doka-dierovaný pás 50x2,0mm 25m Doka-Lochband 50x2,0mm 25m  Dovolená nosnosť: v závislosti od fundamentového upínača použitého debniaceho systému.	17,0	588206000			
Napojenie lešenárskej trubky Gerüstrohranschluss  pozink. výška: 7 cm	0,27	584375000			
Oporný uholník Abstützwinkel  pozink. dĺžka: 66 cm šírka: 37 cm výška: 91 cm	10,7	588477000			
Priskrutkovač spojka 48mm 50 Anschraubkupplung 48mm 50  pozink. veľkosť kľúča: 22 mm	0,84	682002000			
Frami-zátka kotevného otvoru Frami-Ankerstopfen  hnedá priemer: 2,5 cm	0,002	588444000			
Doka-štvorianová reťaz 3,20m Doka-Vierstrangkette 3,20m  Max. nosnosť pri uhle sklonu $\beta = 30^\circ$: 2400 kg (2-lanové) alebo 3600 kg (4-lanové) Dodržujte návod na použitie!	15,0	588620000			CE

	[kg]	Č. výrobku
Dokamatic-transportný popruh 13,00m Dokamatic-Umsetzgurt 13,00m	10,5	586231000



zelená
max.nosnosť: 2000 kg
Dodržujte návod na použitie!
Označenie GS platí len pre popruh!



Frami-paleta 1,20m Frami-Palette 1,20m	68,0	588478000
--	------	-----------

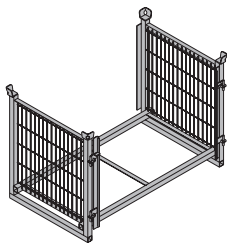

pozink.
dĺžka: 138 cm
šírka: 100 cm
výška: 114 cm
max.nosnosť: 800 kg
Dodržujte návod na použitie!



Frami-paleta 1,50m Frami-Palette 1,50m	74,0	588476000
--	------	-----------

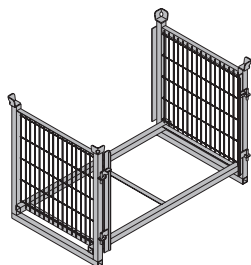

pozink.
dĺžka: 168 cm
šírka: 100 cm
výška: 114 cm
max.nosnosť: 800 kg
Dodržujte návod na použitie!



Alu-Framax-paleta Alu-Framax-Palette	126,7	588396000
--	-------	-----------

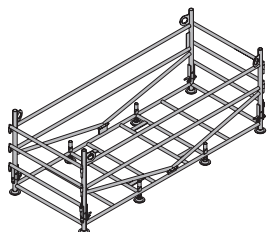

pozink.
dĺžka: 280 cm
šírka: 110 cm
výška: 107 cm
stav dodávky: zložená
max.nosnosť: 1200 kg
Dodržujte návod na použitie!



Doka-debna pre drobné súčiastky Doka-Kleinteilebox	106,4	583010000
--	-------	-----------

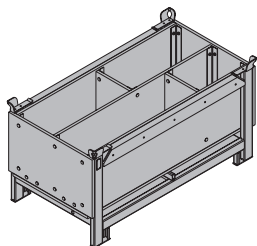

drevené časti lazúrované na žito
oceľové časti pozinkované
dĺžka: 154 cm
šírka: 83 cm
výška: 77 cm
max.nosnosť: 1000 kg
Dodržujte návod na použitie!



Pripájacie koleso Anklemm-Radsatz	33,5	586154000
---	------	-----------

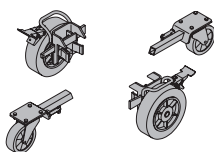

lakované namodro
max.nosnosť: 1100 kg

Výstupový systém XS

Napojenie XS pre sten. debnenie Anschluss XS Wandschalung	20,8	588662000
---	------	-----------

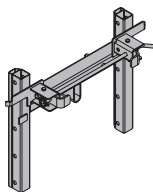

pozink.
šírka: 89 cm
výška: 63 cm

Systémový rebrík XS 4,40m System-Leiter XS 4,40m	33,2	588640000
--	------	-----------

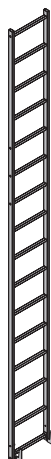

pozink.

Predĺženie rebríka XS 2,30m Leiternverlängerung XS 2,30m	19,1	588641000
--	------	-----------

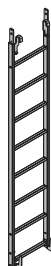

pozink.

Poistné zábradlie XS Sicherungsschranke XS	4,9	588669000
--	-----	-----------

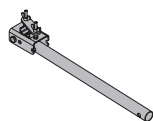

pozink.
dĺžka: 80 cm

Ochranný kôš XS 1,00m Ochranný kôš XS 0,25m	16,5	588643000
	10,5	588670000

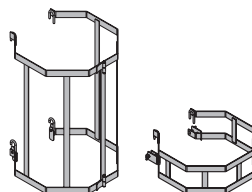

pozink.

	[kg]	Č. výrobku
Ochranný kôš - výstupný diel XS Rückenschutz-Ausstieg XS	17,0	588666000
 <p>pozink. výška: 132 cm</p>		

Rámové debnenie Frami 300

Frami-rámový panel 0,90x3,00m	84,7	588411000
Frami-rámový panel 0,75x3,00m	74,6	588412000
Frami-rámový panel 0,60x3,00m	64,2	588413000
Frami-rámový panel 0,45x3,00m	52,8	588414000
Frami-rámový panel 0,30x3,00m	43,5	588415000
Frami-rámový panel 0,90x1,50m	43,3	588406000
Frami-rámový panel 0,75x1,50m	39,7	588448000
Frami-rámový panel 0,60x1,50m	35,0	588464000
Frami-rámový panel 0,45x1,50m	28,2	588409000
Frami-rámový panel 0,30x1,50m	23,0	588410000
Frami-Rahmenelement		

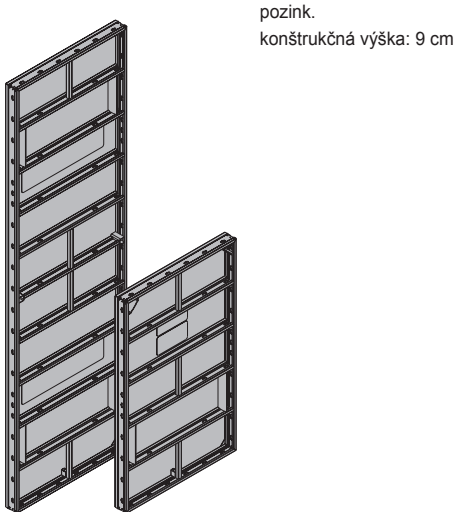

Frami-univerzálny panel 0,75x3,00m	90,9	588416000
Frami-univerzálny panel 0,75x1,50m	46,6	588407000
Frami-Universalelement		

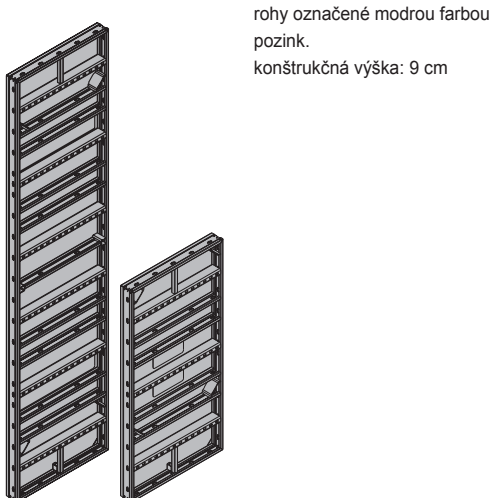

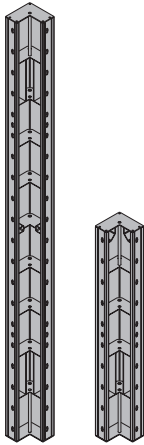
	[kg]	Č. výrobku
Frami-vnútrotný roh 3,00m 20cm Frami-Innenecke	57,4	588417000
Frami-vnútrotný roh 1,50m 20cm	30,7	588472000
 <p>pozink.</p>		

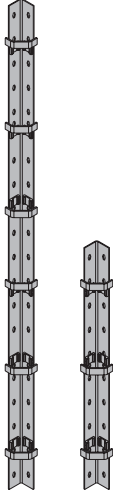
Frami-vonkajší roh 3,00m Frami-Außenecke	25,0	588418000
Frami-vonkajší roh 1,50m	12,9	588460000
 <p>pozink.</p>		