

[kg] Article n°

**Tie rod system 15.0**

Tie rod 15.0mm galvanised 0.50m	0.72	581821000
Tie rod 15.0mm galvanised 0.75m	1.1	581822000
Tie rod 15.0mm galvanised 1.00m	1.4	581823000
Tie rod 15.0mm galvanised 1.25m	1.8	581826000
Tie rod 15.0mm galvanised 1.50m	2.2	581827000
Tie rod 15.0mm galvanised 1.75m	2.5	581828000
Tie rod 15.0mm galvanised 2.00m	2.9	581829000
Tie rod 15.0mm galvanised 2.50m	3.6	581852000
Tie rod 15.0mm galvanised .....m	1.4	581824000
Tie rod 15.0mm non-treated 0.50m	0.73	581870000
Tie rod 15.0mm non-treated 0.75m	1.1	581871000
Tie rod 15.0mm non-treated 1.00m	1.4	581874000
Tie rod 15.0mm non-treated 1.25m	1.8	581886000
Tie rod 15.0mm non-treated 1.50m	2.1	581876000
Tie rod 15.0mm non-treated 1.75m	2.5	581887000
Tie rod 15.0mm non-treated 2.00m	2.9	581875000
Tie rod 15.0mm non-treated 2.50m	3.6	581877000
Tie rod 15.0mm non-treated 3.00m	4.3	581878000
Tie rod 15.0mm non-treated 3.50m	5.0	581888000
Tie rod 15.0mm non-treated 4.00m	5.7	581879000
Tie rod 15.0mm non-treated 6.00m	8.6	581881000
Tie rod 15.0mm non-treated .....m	1.4	581873000
Ankerstab 15,0mm		



<b>Wing nut 15.0</b> Flügelmutter 15,0	0.31	581961000
---	------	-----------



Galvanised  
Length: 10 cm  
Height: 5 cm  
Width-across: 27 mm

<b>Super plate 15.0</b> Superplatte 15,0	1.1	581966000
---	-----	-----------



Galvanised  
Height: 6 cm  
Diameter: 12 cm  
Width-across: 27 mm

<b>Hexagon nut 15.0</b> Sechskantmutter 15,0	0.23	581964000
---	------	-----------



Galvanised  
Length: 5 cm  
Width-across: 30 mm

<b>Anchor plate 12/12</b> Ankerplatte 12/12	1.3	581930000
--	-----	-----------



Galvanised

<b>Anchor plate 15/20</b> Ankerplatte 15/20	1.8	581929000
--	-----	-----------



Galvanised

<b>Angle anchor plate 12/18</b> Winkelplatte 12/18	1.5	581934000
---	-----	-----------

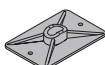

Galvanised

<b>Frami pressure plate 8/9</b> Frami-Druckplatte 8/9	0.55	588466000
--	------	-----------



Galvanised

<b>Top50 form-tie nut 15.0</b> Top50-Ankermutter 15,0	3.8	580073000
--	-----	-----------

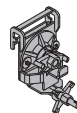

Galvanised  
Height: 25 cm

<b>Fixing plate 15.0</b> Nagelblech 15,0	0.15	581692000
---	------	-----------



Galvanised  
Diameter: 10 cm

<b>Positioning cone 15.0 5cm</b> Vorlaufkonus 15,0 5cm	0.43	581969000
---	------	-----------

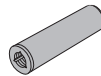

Galvanised  
Length: 11 cm  
Diameter: 3 cm  
Tool: Positioning cone spanner  
15.0 DK  
Follow fitting instructions!

<b>Climbing cone 15.0 5cm</b> Kletterkonus 15,0 5cm	0.97	581980000
--	------	-----------

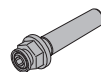

Galvanised  
Length: 17 cm  
Diameter: 6 cm  
Width-across: 41 mm  
Follow fitting instructions!

<b>Sealing sleeve 15.0 5cm</b> Dichtungshülse 15,0 5cm	0.008	581990000
---	-------	-----------



Orange  
Length: 10 cm  
Diameter: 3 cm

<b>She-bolt 15.0 5cm</b> Ankerkopf 15,0 5cm	1.7	581972000
--	-----	-----------



Galvanised  
Length: 76 cm  
Width-across: 24 mm  
Follow fitting instructions!

<b>She-bolt 15.0 5cm 1.20m</b> Ankerkopf 15,0 5cm 1,20m	2.5	581832000
--	-----	-----------



Galvanised  
Length: 131 cm  
Width-across: 24 mm  
Follow fitting instructions!

<b>Cantilever positioning cone 15.0 5cm</b> Sperrenvorlauf 15,0 5cm	0.45	581699000
--	------	-----------



Length: 11 cm  
Diameter: 5 cm  
Tool: Positioning cone spanner  
15.0 DK  
Follow fitting instructions!

<b>Sealing sleeve S 15.0 5cm</b> Dichtungshülse S 15,0 5cm	0.009	581697000
---	-------	-----------



Orange  
Length: 11 cm  
Diameter: 4.7 cm

<b>Fair-faced concrete positioning cone 15.0 5cm</b> Sichtbetonvorlauf 15,0 5cm	0.46	581973000
--	------	-----------



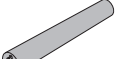

Galvanised  
Length: 11 cm  
Diameter: 4.3 cm  
Tool: Positioning cone spanner  
15.0 DK

	[kg]	Article n°
<b>Suspension cone 15.0 5cm</b> Aufhängekonus 15,0 5cm	0.88	<b>581971000</b>
 Galvanised Length: 16 cm Diameter: 6 cm Follow fitting instructions!		

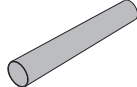
<b>Suspension cone 15.0 f. insulation up to 11cm</b> Aufhängekonus 15,0 für Isolierung bis 11cm	3.6	<b>580495000</b>
 Galvanised Length: 30 cm Diameter: 5 cm		

<b>Sealing sleeve 15.0 f. insulation up to 11cm</b> Dichtungshülse 15,0 für Isolierung bis 11cm	0.05	<b>580498000</b>
 White Length: 30 cm Diameter: 6 cm		

<b>Cone screw Rd28</b> Konusschraube Rd28	0.65	<b>580496000</b>
 Galvanised Length: 9 cm Diameter: 6 cm		

<b>Positioning disk Rd28</b> Vorlaufscheibe Rd28	0.25	<b>580497000</b>
 Galvanised Diameter: 9 cm		

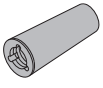
<b>Universal climbing cone 15.0</b> Universal-Kletterkonus 15,0	1.3	<b>581977000</b>
 Galvanised Length: 13 cm Diameter: 5 cm Tool: Spanner for universal climbing cone 15.0/20.0		

<b>Cone screw B 7cm</b> Konusschraube B 7cm	0.86	<b>581444000</b>
 red Length: 10 cm Diameter: 7 cm Width-across: 50 mm		

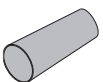
<b>Sealing sleeve K 15.0</b> Dichtungshülse K 15,0	0.03	<b>581976000</b>
 Orange Length: 12 cm Diameter: 6 cm		

<b>Fair-faced concrete positioning cone MF 15.0</b> Sichtbetonvorlauf MF 15,0	1.5	<b>581928000</b>
 Galvanised Length: 12.6 cm Diameter: 5.3 cm Tool: Spanner for universal climbing cone 15.0/20.0		

<b>Positioning disk M30</b> Vorlaufscheibe M30	0.25	<b>581975000</b>
 Galvanised Diameter: 9 cm		

<b>Positioning clamp M30</b> Vorlaufklemme M30	0.19	<b>581833000</b>
 Galvanised Diameter: 4 cm		

	[kg]	Article n°
<b>Screw-in cone 15.0</b> Einschraubkonus 15,0	0.74	<b>581895000</b>
 Galvanised Length: 15 cm		

<b>Bridge edge beam anchor 15.0</b> <b>Bridge edge beam anchor 15.0 galv.</b> Gesimsanker 15,0	0.45 0.44	<b>581896000</b> <b>581890000</b>
 Length: 7 cm Follow fitting instructions!		

<b>Nailing cone 15.0</b> Nagelkonus 15,0	0.02	<b>581897000</b>
 Black Length: 7 cm		

<b>Hole plug 29mm</b> Gesimsankerstopfen 29mm	0.003	<b>581891000</b>
 Grey Diameter: 3 cm		

<b>Zinc plug 15.0</b> Zinkstöpsel 15,0	0.20	<b>581889000</b>
 Galvanised Length: 9.9 cm Diameter: 2.9 cm Tool: Spanner for 1/2" square head		

<b>Stop anchor 15.0 11.5cm 90</b> Sperranker 15,0 11,5cm 90	0.55	<b>581868000</b>
 Non-treated		

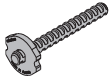
<b>Stop anchor 15.0 16cm 55</b> Sperranker 15,0 16cm 55	0.38	<b>581997000</b>
 Non-treated		

<b>Stop anchor 15.0 40cm 55</b> Sperranker 15,0 40cm 55	0.71	<b>581999000</b>
 Non-treated		

<b>Stop anchor double-ended 15.0 20cm 90</b> Sperranker beidseitig 15,0 20cm 90	0.76	<b>581820000</b>
 Non-treated Custom lengths can be ordered under the special-component Art.n° 580100000, quoting the designation and the desired length in mm.		

<b>Pigtail anchor 15.0</b> Wellenanker 15,0	0.92	<b>581984000</b>
 Non-treated Length: 67 cm		

<b>Wall anchor 15.0 15cm</b> Wandanker 15,0 15cm	1.5	<b>581893000</b>
 Galvanised		

	[kg]	Article n°
<b>Suspension cone 15.0 with collar</b> Bund-Aufhängekonus 15,0	1.4	<b>580428000</b>
 Galvanised Length: 16 cm Diameter: 6 cm Follow fitting instructions!		

<b>Rock anchor spreader unit 15.0</b> Felsanker-Spreizeinheit 15,0	0.41	<b>581120000</b>
 Galvanised Length: 9 cm Diameter: 4 cm Follow fitting instructions!		

<b>Rock anchor installation tube</b> Felsanker-Einbaurohr	0.85	<b>581123000</b>
 Galvanised Length: 50 cm Diameter: 3 cm		

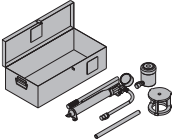
<b>Tensioning instrument 300kN</b> Vorspanngerät 300kN	32.0	<b>581815000</b>
 Galvanised		

<b>Water stop connector 15.0</b> Wasserstopp 15,0	0.52	<b>581914000</b>
 Non-treated Length: 12 cm		

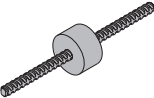
<b>Water stop 15.0 33cm</b> <b>Water stop S 15.0 33cm</b> Wassersperre 15,0	1.3 1.2	<b>581817000</b> <b>581819000</b>
 Non-treated Length: 33 cm Diameter: 7 cm Custom lengths can be ordered under the special-component Art.n° 580100000, quoting the designation and the desired length in mm.		

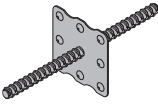
<b>Water stop G 15.0 33cm</b> Wassersperre G 15,0 33cm	0.68	<b>581818000</b>
 Non-treated Length: 33 cm Width: 12 cm Height: 12 cm Custom lengths can be ordered under the special-component Art.n° 580100000, quoting the designation and the desired length in mm.		

<b>Fibre concrete plug 30.7mm</b> <b>Fibre concrete plug 45mm</b> <b>Fibre concrete plug 54mm</b> Faserbetonstopfen	0.03 0.10 0.16	<b>581902000</b> <b>581438000</b> <b>581955000</b>
 Grey		

<b>Concrete cone 52mm</b> Betonkonus 52mm	0.19	<b>581939000</b>
 Grey		

<b>Rod connector 15.0</b> Verbindungsmuffe 15,0	0.49	<b>581981000</b>
 Non-treated Length: 11 cm Diameter: 3 cm		

	[kg]	Article n°
<b>Weldable coupler 15.0</b> Anschweißmuffe 15,0	0.25	<b>581691000</b>
 Non-treated Length: 8 cm Diameter: 3 cm Safety instruction: Must not be welded with the tie-rod screwed in - risk of rod breakage!		<b>DIN 18216</b>

<b>Weldable coupler 15.0 for sheet wall</b> Anschweißmuffe 15,0 für Spundwand	0.75	<b>581693000</b>
 Non-treated Length: 10 cm Height: 13 cm		

<b>Anchor cone 15.0</b> Spannkonus 15,0	0.46	<b>581967000</b>
 Yellow Length: 11 cm Diameter: 6 cm		<b>DIN 18216</b>

<b>Plastic tube 22mm 2.50m</b> Kunststoffrohr 22mm 2,50m	0.45	<b>581951000</b>
		

<b>Universal cone 22mm</b> Universal-Konus 22mm	0.005	<b>581995000</b>
 Grey Diameter: 4 cm		

<b>Plug 22mm</b> Verschlussstopfen 22mm	0.003	<b>581953000</b>
 Grey		

<b>Distance piece 20cm</b> <b>Distance piece 25cm</b> <b>Distance piece 30cm</b> Distanzhalter	0.04 0.05 0.06	<b>581907000</b> <b>581908000</b> <b>581909000</b>
 Grey		

<b>Fibre concrete tube 22mm 0.18m</b> <b>Fibre concrete tube 22mm 0.23m</b> <b>Fibre concrete tube 22mm 0.28m</b> <b>Fibre concrete tube 22mm 0.38m</b> <b>Fibre concrete tube 22mm 1.25m</b> Faserbetonrohr 22mm	0.28 0.36 0.44 0.61 2.3	<b>581904000</b> <b>581905000</b> <b>581906000</b> <b>581903000</b> <b>581991000</b>
--	-------------------------------------	--

<b>Fibre concrete plug 22mm</b> Faserbetonstopfen 22mm	0.02	<b>581992000</b>
		

<b>REPOXAL two component adhesive</b> REPOXAL-Zweikomponenten Kleber	1.2	<b>581993000</b>
---	-----	------------------

<b>Reducer 26/22mm</b> Reduzierstück 26/22mm	0.01	<b>581853000</b>
 Black		

	[kg]	Article n°
<b>Form-ply protector 22mm</b> Schalhautschutz 22mm	0.25	<b>580219000</b>
 Galvanised Width-across: 46 mm		

<b>Form-ply protector 32mm</b> Schalhautschutz 32mm	0.38	<b>580220000</b>
 Galvanised Width-across: 70 mm		

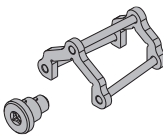
<b>Mounting tool for form-ply protector</b> Montagewerkzeug Schalhautschutz	0.96	<b>580222000</b>
 Galvanised Width: 12 cm Height: 12 cm		

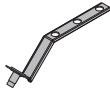
<b>Anchor holder 15.0</b> Ankerhalter 15,0	0.43	<b>581835000</b>
 Non-treated		

<b>Clearance cone 15.0</b> Freistellkonus 15,0	0.51	<b>581865000</b>
 Black Blue Length: 20.6 cm Diameter: 7 cm Follow fitting instructions!		

<b>Clearance-cone dismantling tool</b> Lösewerkzeug Freistellkonus	0.67	<b>581864000</b>
 Galvanised Length: 10.7 cm Width-across: 24 mm		

<b>Protective cap 15.0/20.0</b> Schutzkappe 15,0/20,0	0.03	<b>581858000</b>
 Yellow Length: 6 cm Diameter: 6.7 cm		

<b>Positioning cone spanner 15.0 DK</b> Vorlaufschlüssel 15,0 DK	0.30	<b>580579000</b>
 Galvanised Length: 8 cm Width-across: 30 mm		

<b>Universal cone spanner 15.0/20.0</b> Universal-Konusschlüssel 15,0/20,0	0.90	<b>581448000</b>
 Galvanised Length: 9 cm Width-across: 50 mm		

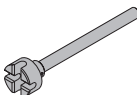
<b>Tie-rod wrench 15.0/20.0</b> Ankerstabschlüssel 15,0/20,0	1.9	<b>580594000</b>
 Galvanised Length: 37 cm Diameter: 8 cm		

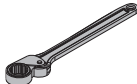
<b>Friction type ratchet SW27</b> Freilaufknarre SW27	0.49	<b>581855000</b>
 manganese-phosphated Length: 30 cm		

	[kg]	Article n°
<b>Box spanner 27 0.65m</b> Steckschlüssel 27 0,65m	1.9	<b>581854000</b>
 Galvanised		

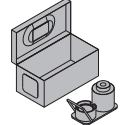
<b>Form-tie load read-off device 300kN</b> Ankerlastanzeigergerät 300kN	12.8	<b>581834500</b>
 Galvanised		

## Tie rod system 20.0

<b>Tie rod 20.0mm galvanised 0.50m</b>	1.3	<b>581411000</b>
<b>Tie rod 20.0mm galvanised 0.75m</b>	1.9	<b>581417000</b>
<b>Tie rod 20.0mm galvanised 1.00m</b>	2.5	<b>581412000</b>
<b>Tie rod 20.0mm galvanised 1.25m</b>	3.2	<b>581418000</b>
<b>Tie rod 20.0mm galvanised 1.50m</b>	3.8	<b>581413000</b>
<b>Tie rod 20.0mm galvanised 2.00m</b>	5.0	<b>581414000</b>
<b>Tie rod 20.0mm galvanised 2.50m</b>	6.3	<b>581430000</b>
<b>Tie rod 20.0mm galvanised .....m</b>	2.5	<b>581410000</b>
<b>Tie rod 20.0mm non-treated 0.50m</b>	1.3	<b>581405000</b>
<b>Tie rod 20.0mm non-treated 0.75m</b>	1.9	<b>581416000</b>
<b>Tie rod 20.0mm non-treated 1.00m</b>	2.5	<b>581406000</b>
<b>Tie rod 20.0mm non-treated 1.50m</b>	3.8	<b>581407000</b>
<b>Tie rod 20.0mm non-treated 2.00m</b>	5.0	<b>581408000</b>
<b>Tie rod 20.0mm non-treated .....m</b>	2.5	<b>581403000</b>
Ankerstab 20,0mm		



**DIN**  
18216

<b>Wing nut 20.0</b> Flügelmutter 20,0	0.47	<b>581466000</b>
 Galvanised Length: 11 cm Height: 6 cm Width-across: 36 mm		

**DIN**  
18216

<b>Hexagon nut 20.0</b> Sechskantmutter 20,0	0.60	<b>581420000</b>
 Galvanised Length: 7 cm Width-across: 41 mm		

**DIN**  
18216







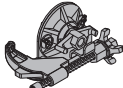

<b>Anchor plate 20.0</b> Ankerplatte 20,0	1.7	<b>581425000</b>
 Galvanised		

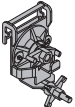
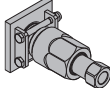
**DIN**  
18216

<b>Super plate 20.0 B</b> Superplatte 20,0 B	2.0	<b>581424000</b>
 Galvanised Height: 7 cm Diameter: 14 cm Width-across: 34 mm		

**DIN**  
18216

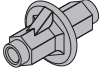
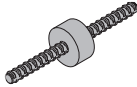
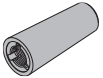
<b>Framax combination nut 20.0</b> Framax-Kombimutter 20,0	6.1	<b>588683000</b>
 Galvanised Width: 27 cm		

	[kg]	Article n°
<b>Framax form-tie nut 20.0</b> Framax-Ankermutter 20,0  Galvanised Width: 19 cm	3.6	<b>588687000</b>
<b>Top100 tec form-tie nut 20.0</b> Top100 tec-Ankermutter 20,0  Galvanised Height: 25 cm	4.8	<b>586934000</b>
<b>Quick-release nut 20.0</b> Lösemutter 20,0  Galvanised Length: 22 cm Follow fitting instructions!	5.9	<b>581428000</b>
<b>She-bolt 20.0</b> Ankerkopf 20,0  Galvanised Length: 140 cm Diameter: 5 cm Width-across: 41 mm 	5.6	<b>581435000</b>
<b>Anchoring cone 20.0</b> Ankerkonus 20,0  Galvanised Length: 15 cm Diameter: 5 cm Tool: Cone spanner 20.0 	1.0	<b>581437000</b>
<b>Sealing sleeve 20.0</b> Dichtungshülse 20,0  Grey Length: 16 cm Diameter: 5 cm	0.03	<b>581441000</b>
<b>Water stop connector 20.0</b> Wasserstopp 20,0  Non-treated Length: 14 cm	1.3	<b>581467000</b>
<b>Water stop 20.0 33cm</b> Wassersperre 20,0 33cm  Non-treated Length: 33 cm Diameter: 8 cm Custom lengths can be ordered under the special-component Art.n° 580100000, quoting the designation and the desired length in mm.	1.7	<b>581426000</b>
<b>Universal climbing cone 20.0</b> Universal-Kletterkonus 20,0  Galvanised Length: 13 cm Diameter: 5 cm Tool: Spanner for universal climbing cone 15.0/20.0	1.2	<b>581442000</b>
<b>Cone screw B 7cm</b> Konusschraube B 7cm  red Length: 10 cm Diameter: 7 cm Width-across: 50 mm	0.86	<b>581444000</b>

	[kg]	Article n°
<b>Sealing sleeve K 20.0</b> Dichtungshülse K 20,0  yellow-green Length: 12 cm Diameter: 6 cm	0.03	<b>581443000</b>
<b>Fibre concrete plug 27mm</b> <b>Fibre concrete plug 35mm</b> <b>Fibre concrete plug 40mm</b> Faserbetonstopfen  Grey	0.03 0.11 0.14	<b>581473000</b> <b>588923000</b> <b>588924000</b>
<b>Concrete cone 52mm</b> Betonkonus 52mm  Grey	0.19	<b>581939000</b>
<b>Fair-faced concrete positioning cone MF 20.0</b> Sichtbetonvorlauf MF 20,0  Galvanised Length: 12.6 cm Diameter: 5.3 cm Tool: Spanner for universal climbing cone 15.0/20.0	1.3	<b>581469000</b>
<b>Positioning disk M30</b> Vorlaufscheibe M30  Galvanised Diameter: 9 cm	0.25	<b>581975000</b>
<b>Positioning clamp M30</b> Vorlaufklemme M30  Galvanised Diameter: 4 cm	0.19	<b>581833000</b>
<b>Pigtail anchor 20.0</b> Wellenanker 20,0  Non-treated Length: 76 cm	2.0	<b>581450000</b>
<b>Stop anchor 20.0 11.5cm 90</b> Sperranker 20,0 11,5cm 90  Non-treated	0.88	<b>581456000</b>
<b>Stop anchor 20.0 17.5cm 55</b> Sperranker 20,0 17,5cm 55  Non-treated	0.62	<b>581457000</b>
<b>Stop anchor 20.0 40cm 55</b> Sperranker 20,0 40cm 55  Non-treated	1.2	<b>581458000</b>
<b>Stop anchor double-ended 20.0 19cm 90</b> Sperranker beidseitig 20,0 19cm 90  Non-treated Custom lengths can be ordered under the special-component Art.n° 580100000, quoting the designation and the desired length in mm.	1.1	<b>581459000</b>

	[kg]	Article n°
<b>Weldable coupler 20.0</b> Anschweißmuffe 20,0	0.55	<b>581474000</b>
 Non-treated Length: 8 cm Diameter: 4 cm Follow fitting instructions!		

<b>Rod connector 20.0</b> Verbindungsmuffe 20,0	0.94	<b>581421000</b>
 Non-treated Length: 15 cm Width-across: 36 mm		

<b>Rock anchor spreader unit 20.0</b> Felsanker-Spreizeinheit 20,0	1.3	<b>581468000</b>
 Galvanised Length: 11.9 cm Diameter: 5.7 cm Follow fitting instructions!		

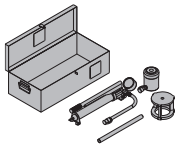
<b>Tensioning instrument 300kN</b> Vorspanngerät 300kN	32.0	<b>581815000</b>
 Galvanised		

<b>Plastic tube 26mm 2.00m</b> Kunststoffrohr 26mm 2,00m	0.59	<b>581463000</b>
		

<b>Universal cone 26mm</b> Universal-Konus 26mm	0.008	<b>581464000</b>
 Grey Diameter: 5 cm		

<b>Plug 26mm</b> Verschlussstopfen 26mm	0.006	<b>581465000</b>
 Grey		

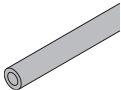
<b>Fibre concrete tube 27mm 1.25m</b> Faserbetonrohr 27mm 1,25m	2.6	<b>581472000</b>
		

<b>Protective cap 15.0/20.0</b> Schutzkappe 15,0/20,0	0.03	<b>581858000</b>
 Yellow Length: 6 cm Diameter: 6.7 cm		

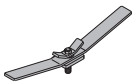
<b>Cone spanner 20.0</b> Konusschlüssel 20,0	3.5	<b>581471000</b>
 Galvanised Length: 57 cm		

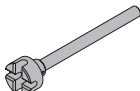
<b>Tie-rod wrench 15.0/20.0</b> Ankerstabschlüssel 15,0/20,0	1.9	<b>580594000</b>
 Galvanised Length: 37 cm Diameter: 8 cm		

	[kg]	Article n°
<b>Universal cone spanner 15.0/20.0</b> Universal-Konusschlüssel 15,0/20,0	0.90	<b>581448000</b>
 Galvanised Length: 9 cm Width-across: 50 mm		

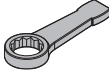

<b>Slugging ring spanner 70</b> Schlag-Ringschlüssel 70	2.6	<b>581429000</b>
 Length: 32 cm		



<b>Anchor holder 20.0</b> Ankerhalter 20,0	0.43	<b>581427000</b>
 Non-treated		

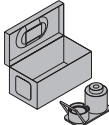

<b>Clearance cone 20.0</b> Freistellkonus 20,0	0.49	<b>581866000</b>
 Black Yellow Length: 20.6 cm Diameter: 7 cm Follow fitting instructions!		

<b>Clearance-cone dismantling tool</b> Lösewerkzeug Freistellkonus	0.67	<b>581864000</b>
 Galvanised Length: 10.7 cm Width-across: 24 mm		











<b>Form-tie load read-off device 300kN</b> Ankerlastanzeigergerät 300kN	12.8	<b>581834500</b>
 Galvanised		



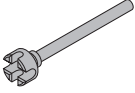
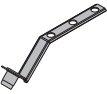

<b>Tie rod system 26.5</b>		
<b>Tie rod 26.5mm non-treated .....m</b> Ankerstab 26,5mm unbehandelt .....m	4.5	<b>581883000</b>
		

<b>Hexagon nut 26.5</b> Sechskantmutter 26,5	0.73	<b>581985000</b>
 Galvanised Length: 8 cm Width-across: 46 mm		

<b>Anchor plate 26.5</b> Ankerplatte 26,5	3.4	<b>581986000</b>
 Galvanised Length: 15 cm Width: 12 cm		

<b>Universal climbing cone 26.5</b> Universal-Kletterkonus 26,5	1.1	<b>581987000</b>
 Galvanised Length: 12.6 cm Diameter: 5 cm Tool: Spanner for universal climbing cone 15.0/20.0		

	[kg]	Article n°
<b>Cone screw B 7cm</b> Konusschraube B 7cm 	0.86	<b>581444000</b>
red Length: 10 cm Diameter: 7 mm Width-across: 50 mm		
<b>Sealing sleeve K 26.5</b> Dichtungshülse K 26,5 	0.02	<b>581998000</b>
light blue Length: 11 cm Diameter: 6 cm		
<b>Rod connector 26.5</b> Verbindungsmuffe 26,5 	1.4	<b>581988000</b>
Non-treated Length: 15 cm Width-across: 46 mm		<b>DIN</b> <b>18216</b>
<b>Pigtail anchor 26.5</b> Wellenanker 26,5 	3.6	<b>581900000</b>
Non-treated Length: 80 cm		
<b>Plastic tube 32mm 2.00m</b> Kunststoffrohr 32mm 2,00m 	0.60	<b>581460000</b>
Diameter: 4 cm		
<b>Universal cone 32mm</b> Universal-Konus 32mm 	0.008	<b>581461000</b>
Grey Diameter: 5 cm		
<b>Universal cone spanner 15.0/20.0</b> Universal-Konusschlüssel 15,0/20,0 	0.90	<b>581448000</b>
Galvanised Length: 9 cm Width-across: 50 mm		
<b>Concrete cone 52mm</b> Betonkonus 52mm 	0.19	<b>581939000</b>
Grey		
<b>Tie-rod wrench 20.0/26.5</b> Ankerstabschlüssel 20,0/26,5 	1.7	<b>580593000</b>
Galvanised Length: 37 cm Diameter: 8 cm		
<b>Anchor holder 26.5</b> Ankerhalter 26,5 	0.43	<b>581943000</b>
Non-treated		
<b>Clearance cone 26.5</b> Freistellkonus 26,5 	0.46	<b>581867000</b>
Black Grey Length: 20.6 cm Diameter: 7 cm Follow fitting instructions!		

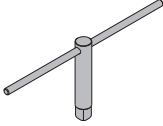
	[kg]	Article n°
<b>Clearance-cone dismantling tool</b> Lösewerkzeug Freistellkonus 	0.67	<b>581864000</b>
Galvanised Length: 10.7 cm Width-across: 24 mm		
<b>Tie rod system 32.0</b>		
<b>Tie rod 32.0mm non-treated .....m</b> Ankerstab 32,0mm unbehandelt .....m 	6.5	<b>582914000</b>
<b>Hexagon nut 32.0</b> Sechskantmutter 32,0 	1.8	<b>582915000</b>
Non-treated Length: 9 cm Width-across: 55 mm		
<b>Anchor plate 32.0</b> Ankerplatte 32,0 	4.1	<b>582916000</b>
Non-treated Length: 15 cm Width: 15 cm		
<b>Anchoring cone 32.0</b> Ankerkonus 32,0 	7.7	<b>582917000</b>
Galvanised Length: 22.5 cm Diameter: 10 cm		
<b>Square spanner 32.0</b> Vierkantschlüssel 32,0 	5.3	<b>582918000</b>
Galvanised Length: 59 cm		